

## **2A Sink/Source Bus Termination Regulator**

### **❖ GENERAL DESCRIPTION**

The AX1255 is a simple, cost-effective and high-speed linear regulator designed to generate termination voltage in double data rate (DDR) memory system to comply with the JEDEC SSTL\_2 and SSTL\_18 or other specific interfaces such as HSTL, SCSI-2 and SCSI-3 etc. devices requirements. The regulator is capable of actively sinking or sourcing up to 2A while regulating an output voltage to within 40mV. The output termination voltage can be tightly regulated to track  $1/2V_{DDQ}$  by two external voltage divider resistors or the desired output voltage can be programmed by externally forcing the REFEN pin voltage.

The AX1255 also incorporates a high-speed differential amplifier to provide ultra-fast response in line/load transient. Other features include extremely low initial offset voltage, excellent load regulation, current limiting in bi-directions and on-chip thermal shut-down protection.

The AX1255 are available in the SOP-8L-EP (Exposed Pad) surface mount packages.

### **❖ FEATURES**

- Ideal for DDR-I, DDR-II, DDR-III and DDR-IV VTT Applications
- Sink and Source 2A Continuous Current
- Integrated Power MOSFETs
- Generates Termination Voltage for SSTL\_2, SSTL\_18, HSTL, SCSI-2 and SCSI-3 Interfaces.
- High Accuracy Output Voltage at Full-Load
- Output Voltage traces REFEN Pin Voltage.
- Low External Component Count
- Shutdown for Suspend to RAM (STR) Functionality with High-Impedance Output
- Current Limiting Protection
- Thermal Shutdown Protection
- SOP-8L with exposed pad Pb-Free Package.
- RoHS and Halogen free compliance

❖ **BLOCK DIAGRAM**

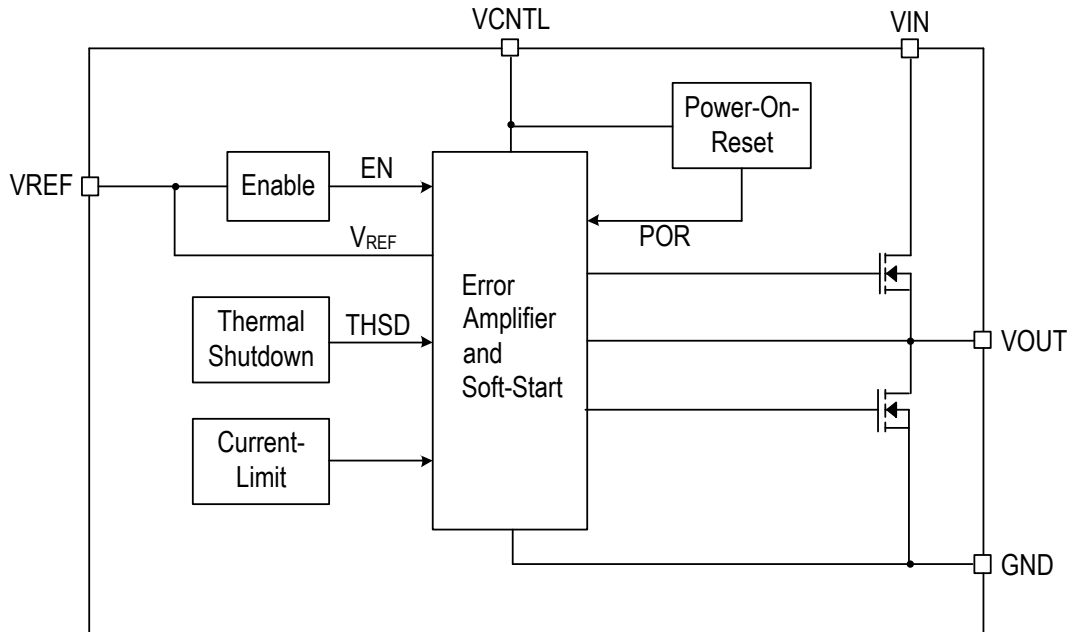

❖ **PIN ASSIGNMENT**

The package of AX1255 is SOP-8L-EP; the pin assignment is given by:

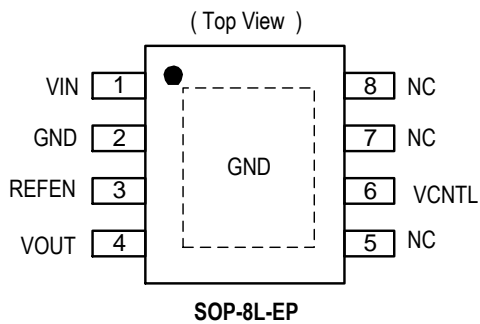

Name	Description
<b>VIN</b>	Input Voltage pin
<b>GND</b>	Ground pin
<b>REFEN</b>	Reference voltage input and chip enable pin
<b>VOUT</b>	Output Voltage pin
<b>VCNTL</b>	Supply Input and Gate drive voltage pin
<b>NC</b>	No connect pin

❖ **ORDER/MARKING INFORMATION**

Order Information	Top Marking
<p><b>AX1255 XX X</b></p> <p>Package Type ES: SOP-8L-EP</p> <p>Packing Blank: Tube A : Taping</p>	<p>Logo ← <b>AX</b> 1 2 5 5 → Part number</p> <p>YYWWX → ID code: internal</p> <p>WW: 01 ~ 52</p> <p>Year: 18=2018 19=2019 20=2020 21=2021 22=2022 . 45=2045</p>

### ❖ ABSOLUTE MAXIMUM RATINGS (T<sub>A</sub> = 25°C)

Characteristics	Symbol	Rating	Unit
VIN Supply Voltage	V <sub>IN</sub>	6	V
Control Voltage	V <sub>CNTL</sub>	6	V
Power Dissipation	PD	Internally Limited	W
Storage Temperature Range	T <sub>ST</sub>	-65 to +150	°C
Thermal Resistance from Junction to case	θ <sub>JC</sub>	15	°C/W
Thermal Resistance from Junction to ambient	θ <sub>JA</sub>	75	°C/W

Note: θ<sub>JA</sub> is measured with the PCB copper area (need connect to Exposed pad) of approximately 1.5 in<sup>2</sup> (Multi-layer).

### ❖ OPERATING RATING

Parameter	Symbol	Value	Unit
Input Voltage	V <sub>IN</sub>	1.2 to V <sub>CNTL</sub>	V
Control Voltage	V <sub>CNTL</sub>	5 or 3.3	V
Ambient Temperature	T <sub>A</sub>	-40 to +85	°C
Junction Temperature	T <sub>J</sub>	-40 to +125	°C

Note: V<sub>OS</sub> offset is the voltage measurement defined as V<sub>OUT</sub> subtracted from V<sub>REFEN</sub>.

### ❖ ELECTRICAL CHARACTERISTICS

V<sub>IN</sub>=2.5V, V<sub>CNTL</sub>=3.3V, V<sub>REFEN</sub>=1.25V, C<sub>OUT</sub>=10μF (Ceramic), T<sub>A</sub>=25°C, unless otherwise specified

Characteristics	Symbol	Conditions	Min	Typ	Max	Units
Gate Drive Voltage Range	V <sub>CNTL</sub>		-	3.3	5.5	V
POR Threshold	V <sub>CNTLRTH</sub>		-	2.5	-	V
POR Hysteresis	V <sub>CNTL</sub>		-	0.1	-	V
Input Voltage	V <sub>IN</sub>		1.2	-	V <sub>CNTL</sub>	V
Quiescent Current	I <sub>CNTL</sub>	I <sub>OUT</sub> =0A	-	750	3000	μA
Standby Current	I <sub>STBY</sub>	V <sub>REFEN</sub> <0.2V	-	50	90	μA
Output Offset Voltage (Note1)	V <sub>OS</sub>	I <sub>OUT</sub> =0A	-12	-	+12	mV
Load Regulation (Note2)	ΔV <sub>LOAD</sub>	I <sub>OUT</sub> =±2.0A	-	0.5	±2	%
Shutdown Threshold	V <sub>IH</sub>	Enable, REFEN Rising	0.55	-	-	V
	V <sub>IL</sub>	Shutdown, REFEN Falling	-	-	0.2	V
Current Limit	I <sub>CL-Source</sub>	Sourcing	2.2	-	-	A
	I <sub>CL-Sink</sub>	Sinking	2.2	-	-	A
Soft-Start Period	T <sub>SS</sub>	V <sub>OUT</sub> =1.25V	-	-	30	μS
Thermal Shutdown	T <sub>SD</sub>		-	160	-	°C
Thermal Shutdown Hysteresis	T <sub>SDH</sub>		-	30	-	°C

**Note 1:** V<sub>OS</sub> offset is the voltage measurement defined as V<sub>OUT</sub> subtracted from V<sub>REFEN</sub>.

**Note 2:** Regulation is measured at constant junction temperature by using a 5ms current pulse. Devices are tested for load regulation in the load range from 0A to 2A.

❖ APPLICATION CIRCUIT

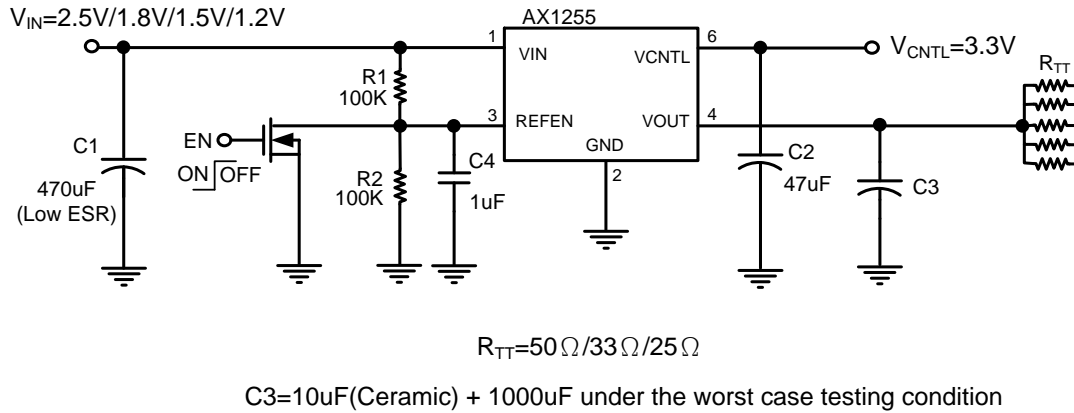

❖ APPLICATION INFORMATION

Input Capacitor and Layout Consideration

Place the input bypass capacitor as close as possible to the AX1255. A low ESR capacitor larger than 470uF is recommended for the input capacitor. Use short and wide traces to minimize parasitic resistance and inductance. Inappropriate layout may result in large parasitic inductance and cause undesired oscillation between AX1255 and the preceding power converter.

Consideration while designs the resistance of voltage divider

Make sure the sinking current capability of pull-down NMOS if the lower resistance was chosen so that the voltage on  $V_{REFEN}$  is below 0.2V. In addition, the capacitor and voltage divider form the low pass filter. There are two reasons doing this design; one is for output voltage soft-start while another is for noise immunity.

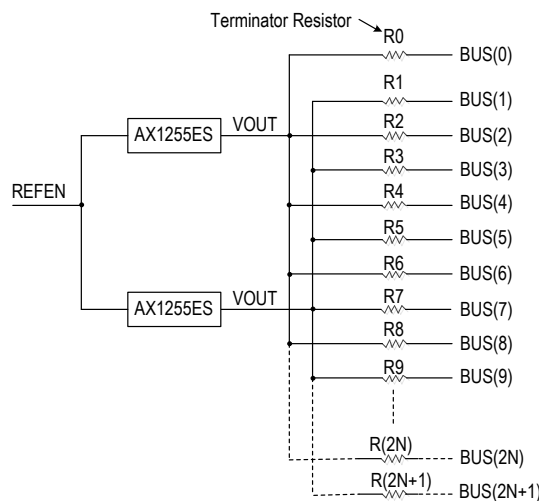

## Thermal Considerations

The AX1255 series can deliver a current of up to 2A over the full operating junction temperature range. However, the maximum output current must be dated at higher ambient temperature to ensure the junction temperature does not exceed 125°C. With all possible conditions, the junction temperature must be within the range specified under operating conditions. Power dissipation can be calculated based on the output current and the voltage drop across regulator.

$$PD = (V_{IN} - V_{OUT}) \times I_{OUT} + V_{IN} \times I_Q$$

The final operating junction temperature for any set of conditions can be estimated by the following thermal equation:

$$PD (MAX) = (T_{J (MAX)} - T_A) / \theta_{JA}$$

Where  $T_{J (MAX)}$  is the maximum junction temperature of the die (125°C) and  $T_A$  is the maximum ambient temperature. The junction to ambient thermal resistance ( $\theta_{JA}$ ) for SOP-8L-EP (Exposed pad) package at recommended minimum footprint is 75°C/W on 1.5 in<sup>2</sup> and Multi-layer PCB layout. The maximum power dissipation at  $T_A = 25^\circ\text{C}$  can be calculated by following formula:

$$PD (MAX) = (125^\circ\text{C} - 25^\circ\text{C}) / 75^\circ\text{C/W} = 1.33\text{W}$$

The thermal resistance  $\theta_{JA}$  of SOP-8L-EP (Exposed Pad) is determined by the package design and the PCB design. However, the package design has been decided. If possible, it's useful to increase thermal performance by the PCB design. The thermal resistance can be decreased by adding copper under the expose pad of SOP-8L-EP package. We have to consider the copper couldn't stretch infinitely and avoid the tin overflow.

❖ TYPICAL CHARACTERISTICS

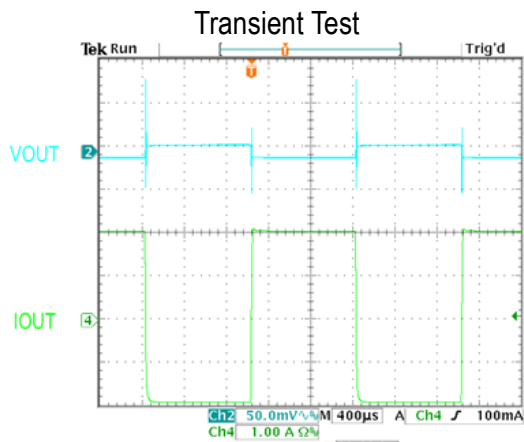

$V_{IN}=2.5V, V_{OUT}=1.25V,$   
 $V_{CNL}=3.3V, I_{OUT}=-1.5A\sim 1.5A$

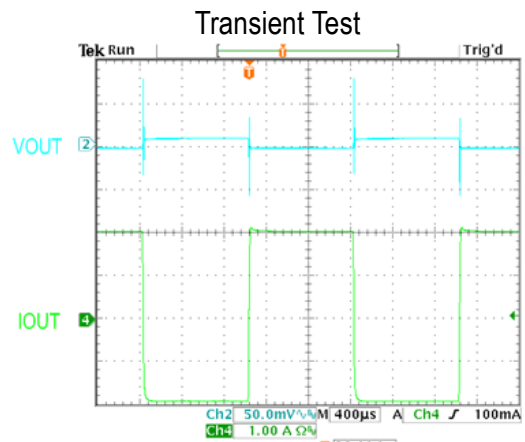

$V_{IN}=1.8V, V_{OUT}=0.9V,$   
 $V_{CNL}=3.3V, I_{OUT}=-1.5A\sim 1.5A$

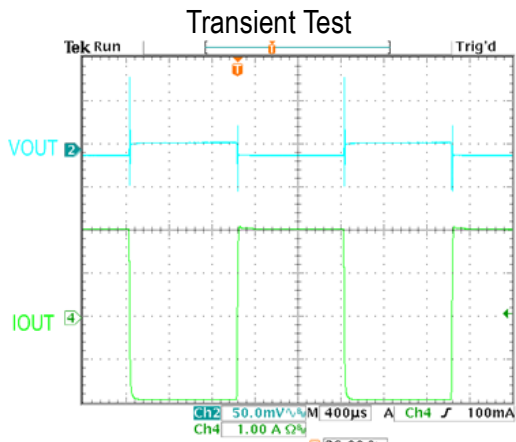

$V_{IN}=1.5V, V_{OUT}=0.75V,$   
 $V_{CNL}=3.3V, I_{OUT}=-1.5A\sim 1.5A$

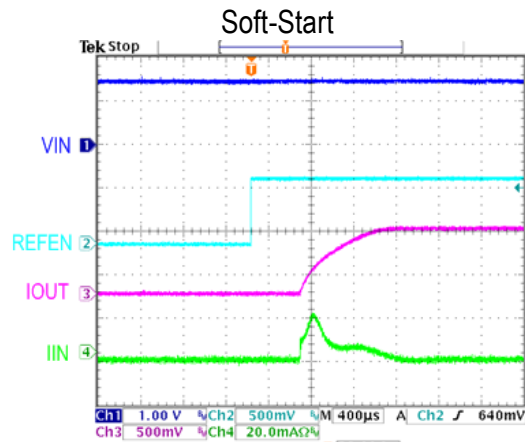

$V_{IN}=1.5V, V_{OUT}=0.75V, V_{CNL}=3.3V$

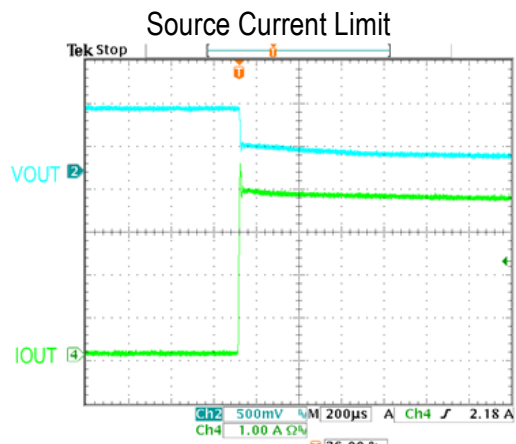

$V_{IN}=1.5V, V_{OUT}=0.75V, V_{CNL}=3.3V$

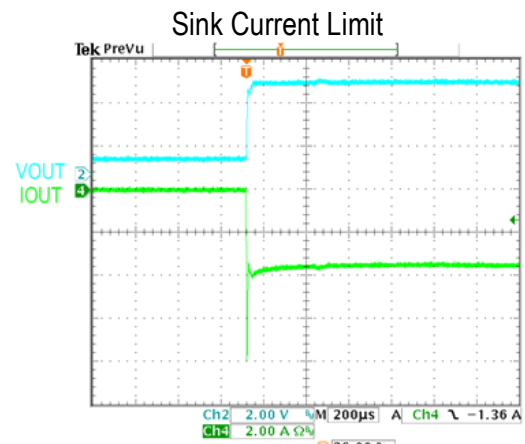

$V_{IN}=1.5V, V_{OUT}=0.75V, V_{CNL}=3.3V$

❖ TYPICAL CHARACTERISTICS (COUNTINOUS)

DDR-II

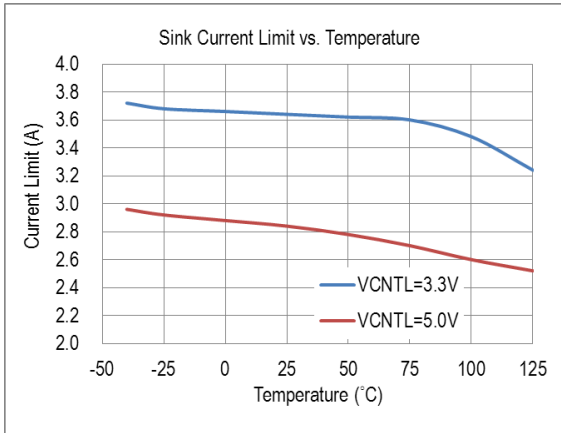

DDR-II

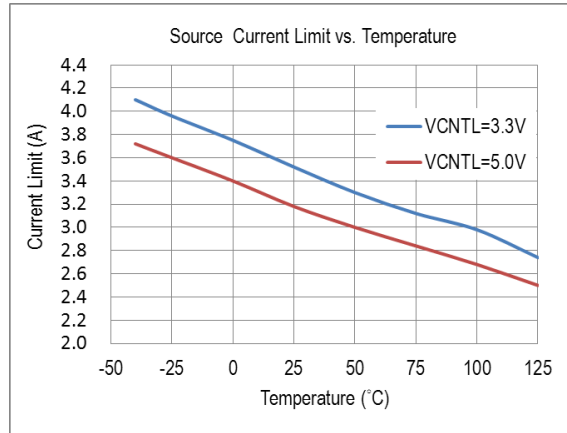

DDR-I

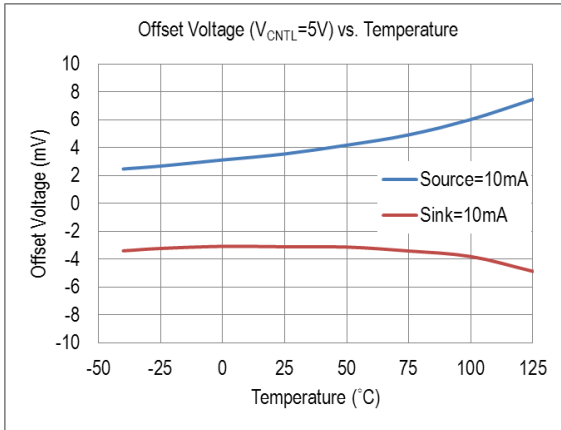

DDR-I

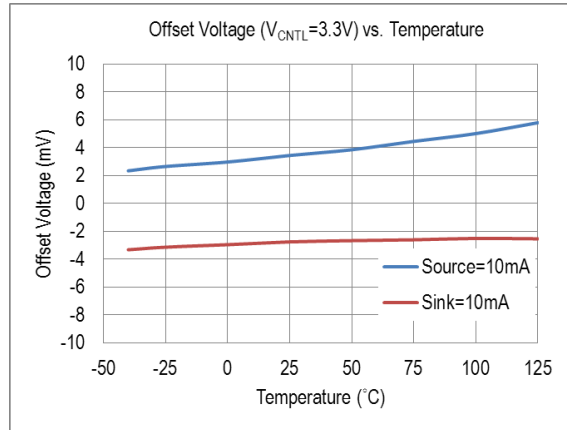

DDR-II

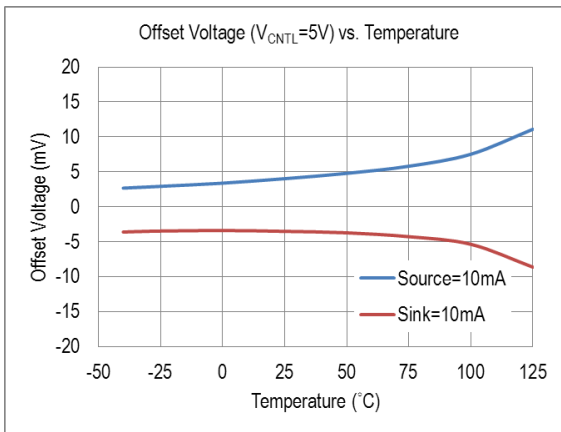

DDR-II

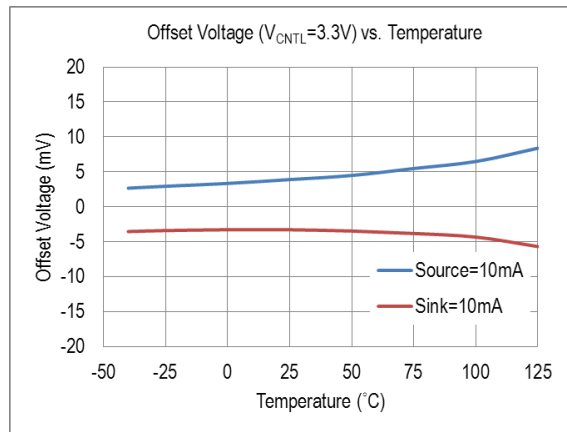

❖ TYPICAL CHARACTERISTICS (COUNTINOUS)

DDR-III

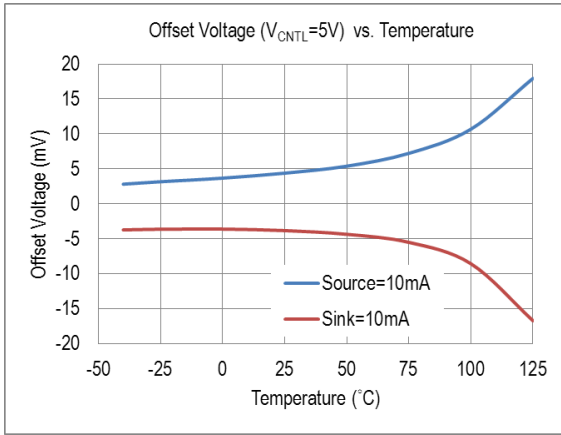

DDR-III

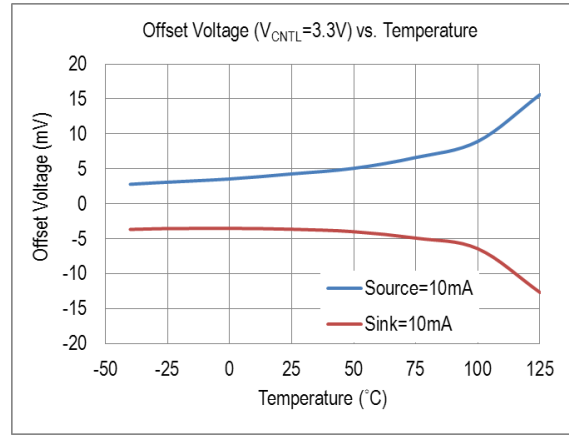

DDR-I

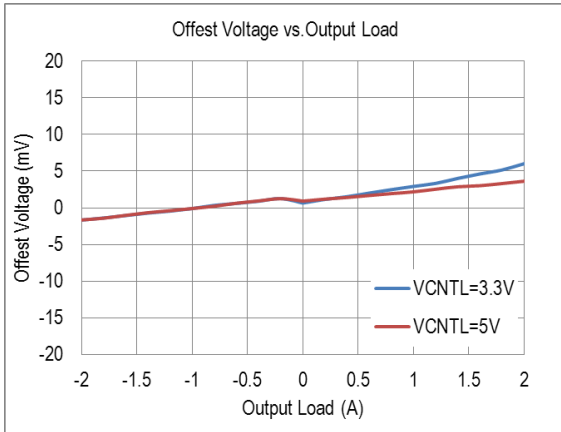

DDR-II

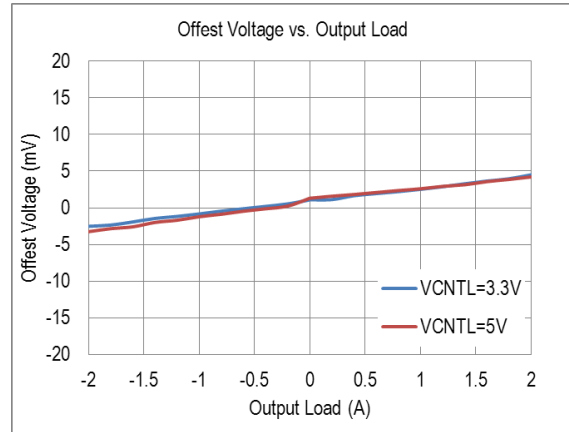

DDR-III

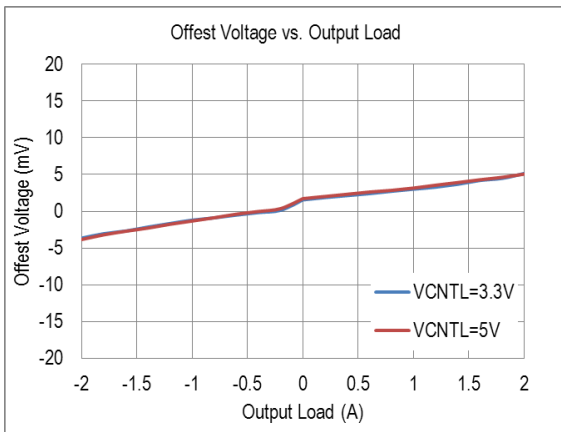

DDR-IV

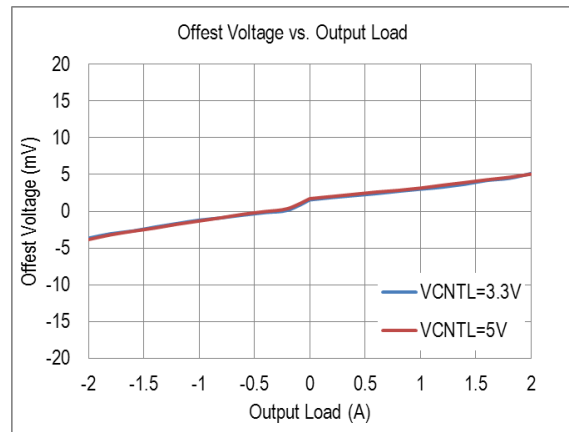



❖ PACKAGE OUTLINES

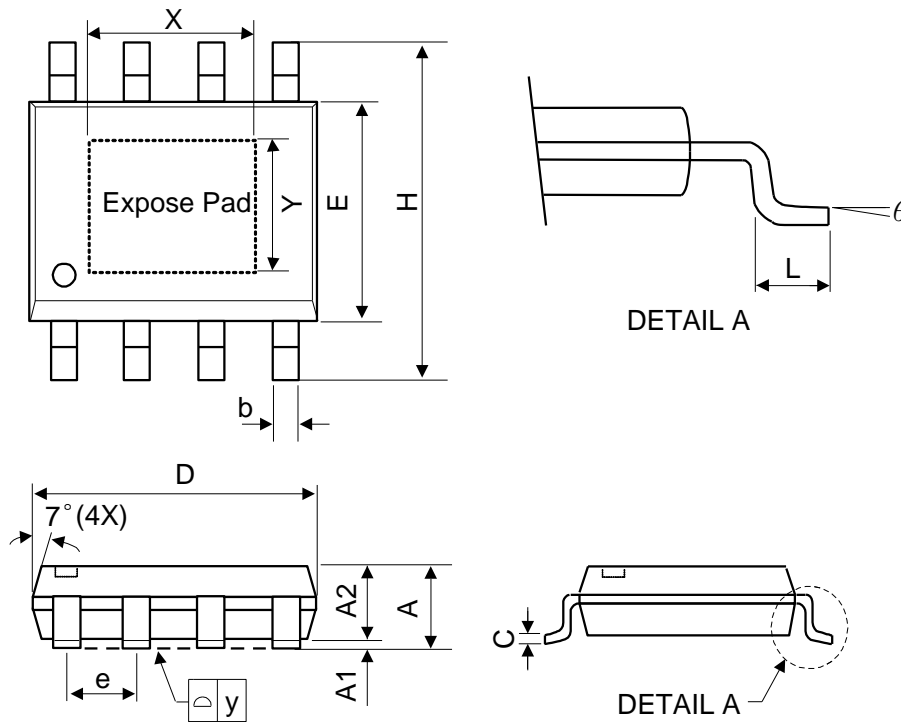

Symbol	Dimensions in Millimeters			Dimensions in Inches		
	Min.	Nom.	Max.	Min.	Nom.	Max.
A	-	-	1.75	-	-	0.069
A1	0	-	0.15	0	-	0.06
A2	1.25	-	-	0.049	-	-
C	0.1	0.2	0.25	0.0075	0.008	0.01
D	4.7	4.9	5.1	0.185	0.193	0.2
E	3.7	3.9	4.1	0.146	0.154	0.161
H	5.8	6	6.2	0.228	0.236	0.244
L	0.4	-	1.27	0.015	-	0.05
b	0.31	0.41	0.51	0.012	0.016	0.02
e	1.27 BSC			0.050 BSC		
y	-	-	0.1	-	-	0.004
X	-	2.34	-	-	0.092	-
Y	-	2.34	-	-	0.092	-
θ	0°	-	8°	0°	-	8°

Mold flash shall not exceed 0.25mm per side

JEDEC outline: MS-012 BA

❖ CARRIER TAPE DIMENSION

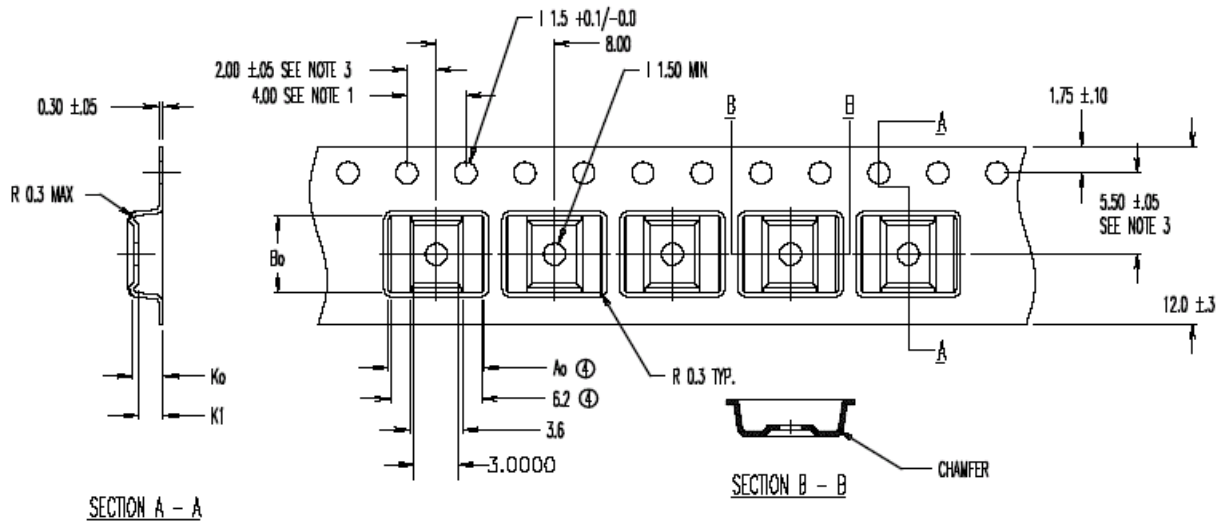

- ④  $A_0 = 6.50$
- $B_0 = 5.20$
- $K_0 = 2.10$
- $K_1 = 1.70$

