

1MHz, 3.2A Synchronous Step-Down Converter

❖ GENERAL DESCRIPTION

The AX3518 is a 1MHz constant frequency current mode PWM step-down converter. It is ideal for portable equipment requiring very high current up to 3.2A from single-cell Lithium-ion batteries while still achieving over 90% efficiency during peak load conditions. The AX3518 also can run at 100% duty cycle for low dropout operation, extending battery life in portable systems while light load operation provides very low output ripple for noise sensitive applications. The AX3518 can supply up to 3.2A output load current from a 2.8V to 5.5V input voltage and the output voltage can be regulated as low as 0.8V. The high switching frequency minimizes the size of external components while keeping switching losses low. The internal slope compensation setting allows the device to operate with smaller inductor values to optimize size and provide efficient operation. The AX3518 is available in adjustable (0.8V to VIN) output voltage. The device is available in SOP-8L-EP and TDFN-8L Pb-free packages.

❖ FEATURES

- 2.8V to 5.5V Input Voltage Range
- Output Voltages from 0.8V to VIN
- High Efficiency: Up to 94%
- 1MHz Constant Frequency Operation
- With power saving mode
- Up to 3.2A Output Current
- No Schottky Diode Required
- Current Mode Operation for Excellent Line and Load Transient Response
- Current limit and thermal shutdown protection
- Short Circuit Protect (SCP)
- Build-in Soft Start function
- SOP-8L-EP and TDFN-8L Pb-Free packages

❖ ORDER/MARKING INFORMATION

Order Information	
AX3518 <u>XX</u> <u>X</u> Package Type Packing ES: SOP-8L-EP A : Taping J8: TDFN-8L (3*3)	
Top Marking (SOP-8L-EP)	Top Marking (TDFN-8L 3*3)
Logo ← AX 3 5 1 8 → Part number YYWWX → ID code: internal WW: 01 ~ 52 Year: 10=2010 11=2011	3 5 1 8 → Part number Y Y W W X → ID code: internal WW: 01~52 Year : 10=2010 11=2011

❖ ABSOLUTE MAXIMUM RATINGS (at T_A=25°C)

Characteristics	Symbol	Rating	Unit
PVIN, SVIN, REF Pin Voltage		V _{SS} - 0.3 to V _{SS} + 6.5	V
Feedback Pin Voltage	V _{FB}	V _{SS} - 0.3 to V _{IN} + 0.3	V
EN Pin Voltage	V _{RUN}	V _{SS} - 0.3 to V _{IN} + 0.3	V
Switch Pin Voltage	V _{SW}	V _{SS} - 0.3 to V _{IN} + 0.3	V
Power Dissipation	PD	(T _J -T _A) / θ _{JA}	mW
Storage Temperature Range	T _{ST}	-40 to +150	°C
Operating Temperature Range	T _{OP}	-40 to +85	°C
Junction Temperature	T _J	+125	°C
Thermal Resistance from Junction to case	SOP-8L-EP	15	°C/W
	TDFN-8L		
Thermal Resistance from Junction to ambient	SOP-8L-EP	40	°C/W
	TDFN-8L	45	

Note: θ_{JA} is measured with the PCB copper area of approximately 1 in²(Multi-layer). That need connect to exposed pad.

❖ ELECTRICAL CHARACTERISTICS

 ($V_{IN} = V_{EN}=3.3V$, $T_A = 25^{\circ}C$, unless otherwise specified)

Characteristics	Symbol	Conditions	Min	Typ	Max	Units
Supply Voltage Range	V_{IN}		2.8	-	5.5	V
Feedback Voltage	V_{FB}		0.784	0.800	0.816	V
Feedback Bias Current	I_{FB}	$V_{FB} = 0.85V$	-	-	± 30	nA
REF Voltage	V_{REF}	$I_{REF}=0$, $V_{IN}=2.8V$ to $5.5V$	-	0.8	-	V
Quiescent Current	I_{CCQ}	$V_{FB} = 1V$	-	250	400	μA
Shutdown Supply Current	I_{SD}	$V_{EN} = 0V$	-	4	10	μA
Switching Current Limit	I_{LIMIT}		3.5	4	-	A
Line Regulation	$\Delta V_{OUT}/V_{OUT}$	$V_{IN} = 3V \sim 5.5V$	-	0.04	0.4	%/V
Load Regulation	$\Delta V_{OUT}/V_{OUT}$	$I_{OUT} = 0.01$ to $3A$	-	0.5	1	%
Oscillation Frequency	F_{OSC}	SW pin	0.8	1	1.2	MHz
$R_{DS(ON)}$ of P-CH MOSFET	$R_{DS(ON)}$	$V_{FB}=0V$, $I_{OUT}=1A$	-	100	-	m Ω
$R_{DS(ON)}$ of N-CH MOSFET	$R_{DS(ON)}$	(Note1)	-	80	-	m Ω
EN pin logic input threshold voltage	V_{ENL}		-	-	0.4	V
	V_{ENH}		1.5	-	-	
EN Pin Input Current	I_{ENH}	$V_{EN}=V_{IN}$	-	± 0.1	± 1	μA
	I_{ENL}	$V_{EN}=0V$	-	4	8	μA
Efficiency	EFFI	$V_{IN}=5V$, $V_{OUT}=3.3V$, $I_{OUT}=2A$	-	92	-	%
Thermal Shutdown	T_{SD}		-	150	-	$^{\circ}C$
Thermal Shutdown Hysteresis	T_{SH}		-	40	-	$^{\circ}C$

Note1: Guaranteed by design.

❖ APPLICATION CIRCUIT

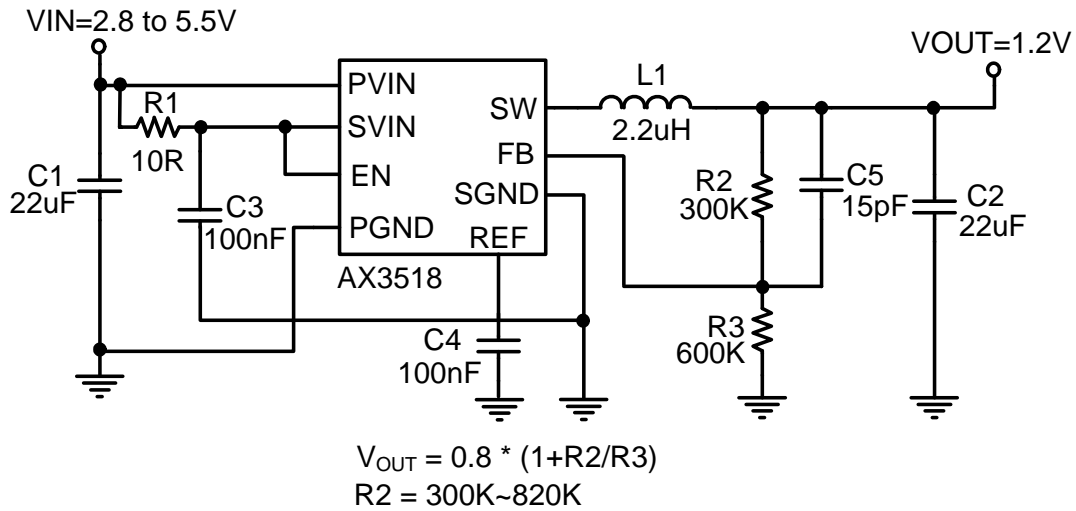

❖ FUNCTION DESCRIPTIONS

Operation

AX3518 is a monolithic switching mode Step-Down DC-DC converter. It utilizes internal MOSFETs to achieve high efficiency and can generate very low output voltage by using internal reference at 0.8V. It operates at a fixed switching frequency, and uses the slope compensated current mode architecture. This Step-Down DC-DC Converter supplies 3200mA output current at input voltage range from 2.8V to 5.5V.

Current Mode PWM Control

Slope compensated current mode PWM control provides stable switching and cycle-by-cycle current limit for excellent load and line responses and protection of the internal main switch (P-CH MOSFET) and synchronous rectifier (N-CH MOSFET). During normal operation, the internal P-CH MOSFET is turned on for a certain time to ramp the inductor current at each rising edge of the internal oscillator, and switched off when the peak inductor current is above the error voltage. The current comparator, I_{COMP} limits the peak inductor current. When the main switch is off, the synchronous rectifier will be turned on immediately and stay on until either the inductor current starts to reverse, as indicated by the current reversal comparator, I_{ZERO} , or the beginning of the next clock cycle.

❖ **APPLICATION INFORMATION**

Setting the Output Voltage

Application circuit item shows the basic application circuit with AX3518 adjustable output version. The external resistor sets the output voltage according to the following equation:

$$V_{OUT} = 0.8V \times \left(1 + \frac{R2}{R3}\right)$$

Table 1 Resistor select for output voltage setting

V _{OUT}	R3	R2
1.2V	600K	300K
1.5V	380K	330K
1.8V	310K	390K
2.5V	220K	470K
3.3V	150K	470K

Inductor Selection

For most designs, the AX3518 operates with inductors of 2.2μH to 3.3μH. Low inductance values are physically smaller but require faster switching, which results in some efficiency loss.

Where is inductor Ripple Current. Large value inductors lower ripple current and small value inductors result in high ripple currents. Choose inductor ripple current approximately 15% of the maximum load current 3200mA, ΔI_L = 480mA.

For output voltages above 3.0V, when light-load efficiency is important, the recommended inductor is 2.2μH. For optimum voltage-positioning load transients, choose an inductor with DC series resistance in the 30mΩ to 100mΩ range. For higher efficiency at heavy loads (above 300mA), or minimal load regulation (but some transient overshoot), the resistance should be kept below 100mΩ. The DC current rating of the inductor should be at least equal to the maximum load current plus half the ripple current to prevent core saturation (3200mA + 240mA).

Input Capacitor Selection

The input capacitor reduces the surge current drawn from the input and switching noise from the device. The input capacitor impedance at the switching frequency shall be less than input source impedance to prevent high frequency switching current passing to the input. A low ESR input capacitor sized for maximum RMS current must be used. Ceramic capacitors with X5R or X7R dielectrics are highly recommended because of their low ESR and small temperature coefficients. A 22μF ceramic capacitor for most applications is sufficient.

Output Capacitor Selection

The output capacitor is required to keep the output voltage ripple small and to ensure regulation loop stability. The output capacitor must have low impedance at the switching frequency. Ceramic capacitors with X5R or X7R dielectrics are recommended due to their low ESR and high ripple current. A 22 μ F ceramic capacitor for most applications is sufficient.

Compensation Capacitor Selection

The compensation capacitor (C5) for increasing phase margin provides additional stability. Refer to Demo Board Schematic, The C5 optimum value is 15pF for all conditions.

Layout Guide

AX3518 TDFN-8L and SOP-8L-EP are the same layout.

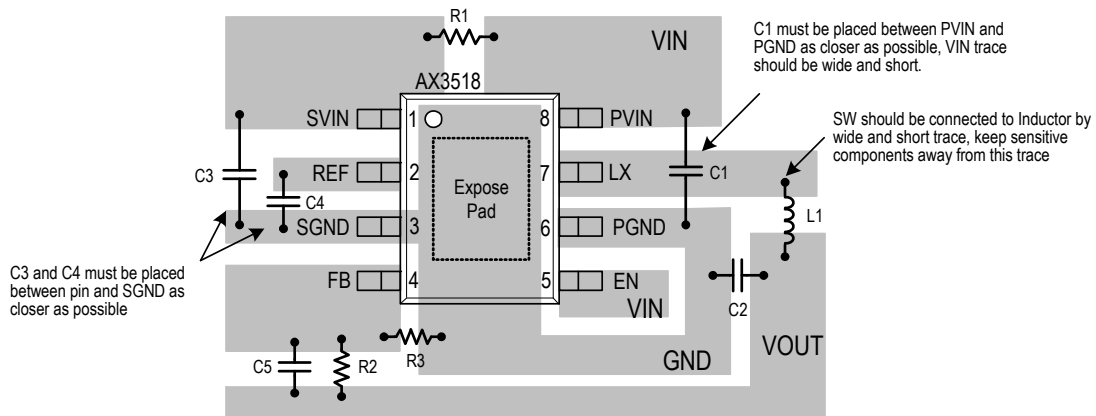

❖ TYPICAL CHARACTERISTICS

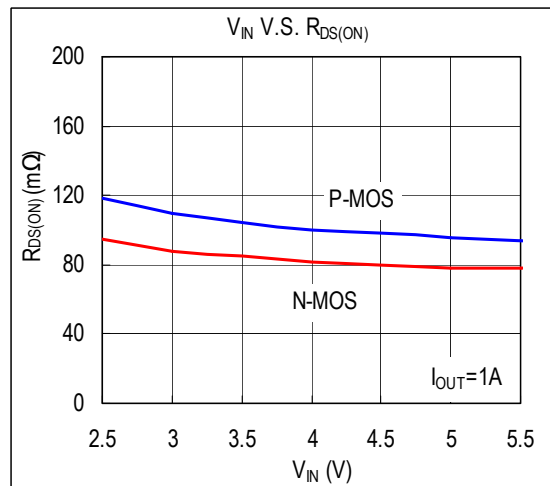
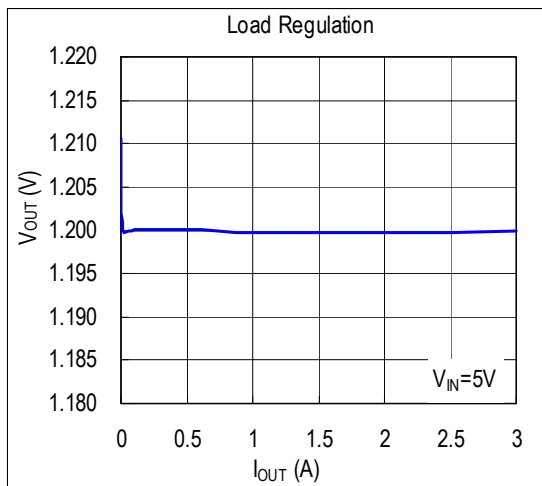
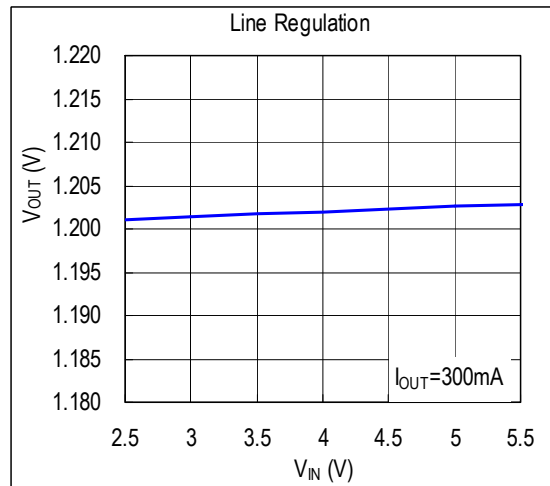
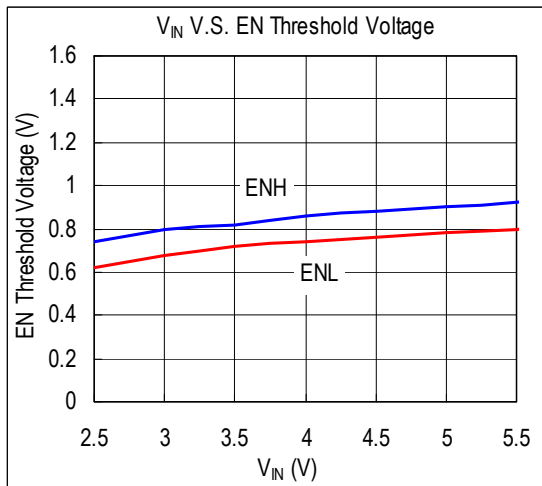
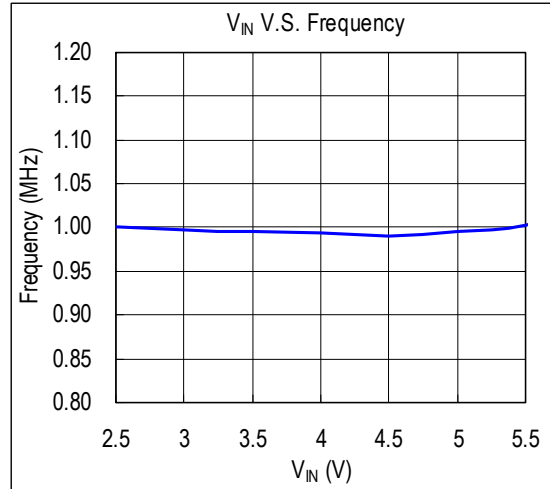
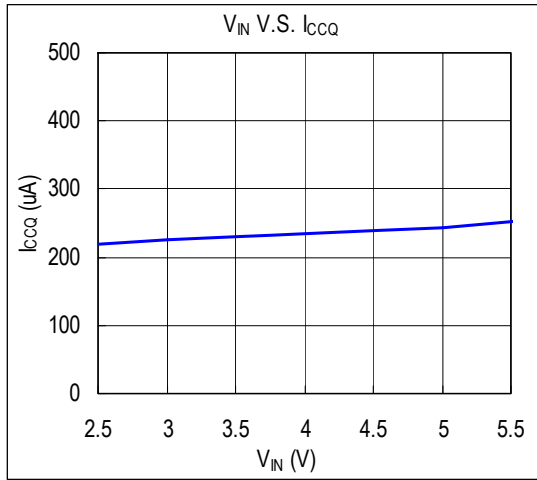

❖ TYPICAL CHARACTERISTICS (CONTINUES)

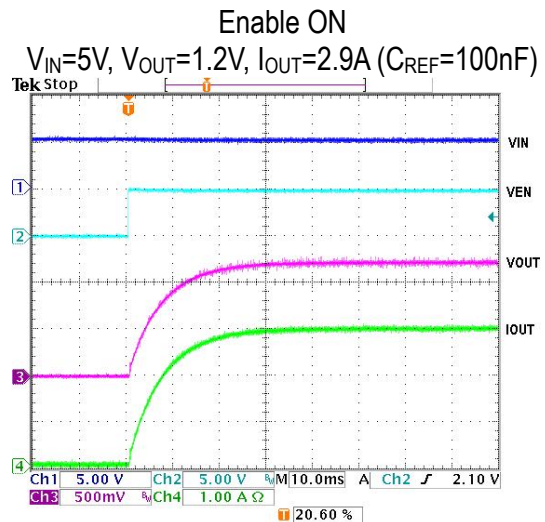
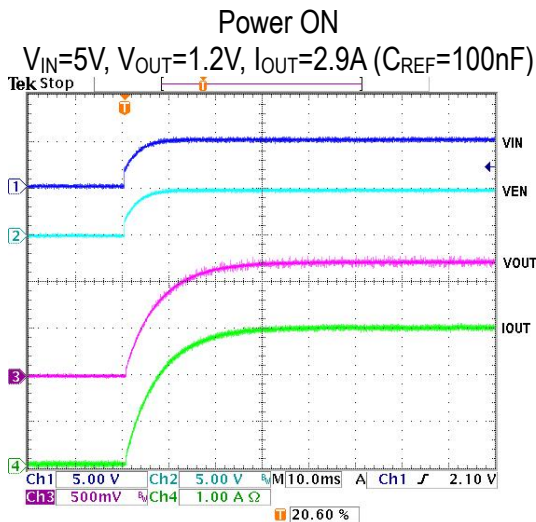
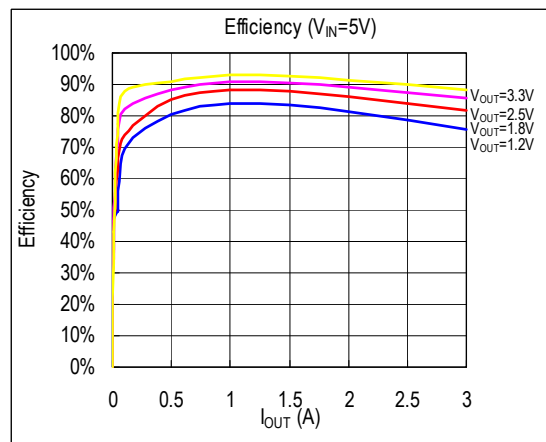
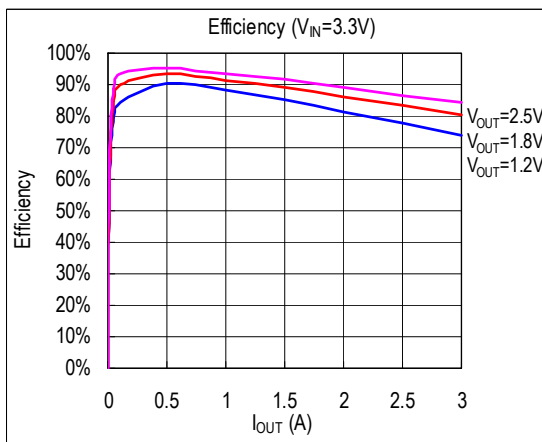
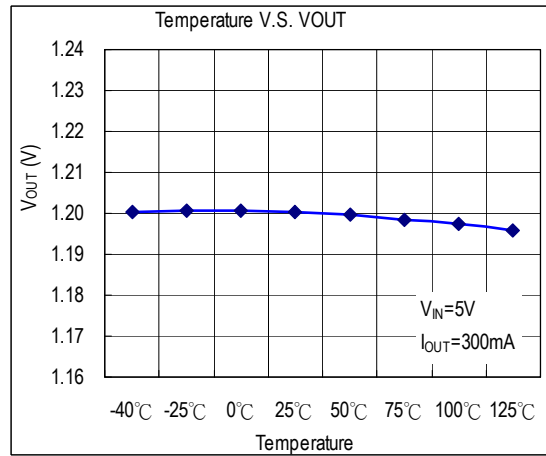
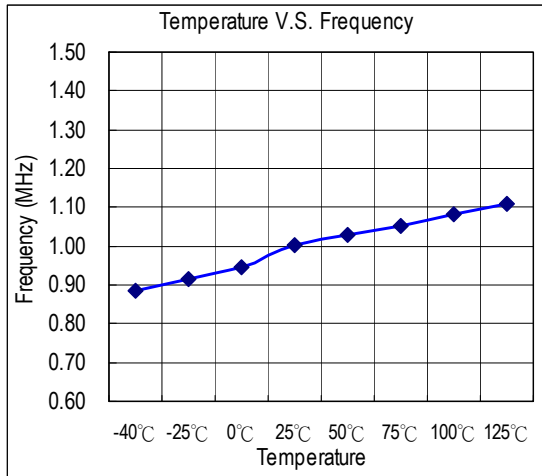

❖ TYPICAL CHARACTERISTICS (CONTINUES)

Power ON

$V_{IN}=5V, V_{OUT}=1.2V, I_{OUT}=2.9A$ ($C_{REF}=10nF$)

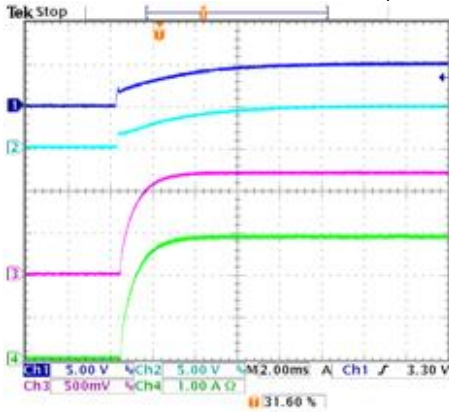

Enable ON

$V_{IN}=5V, V_{OUT}=1.2V, I_{OUT}=2.9A$ ($C_{REF}=10nF$)

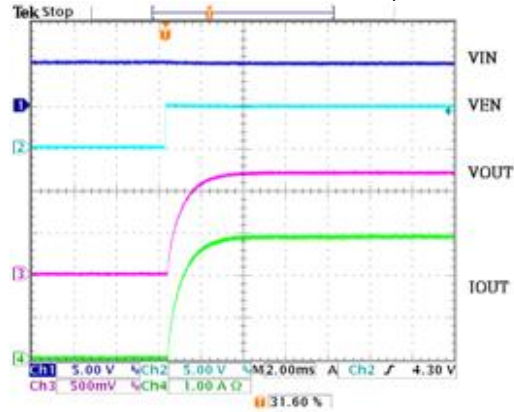

Power ON

$V_{IN}=5V, V_{OUT}=3.3V, I_{OUT}=2.9A$ ($C_{REF}=10nF$)

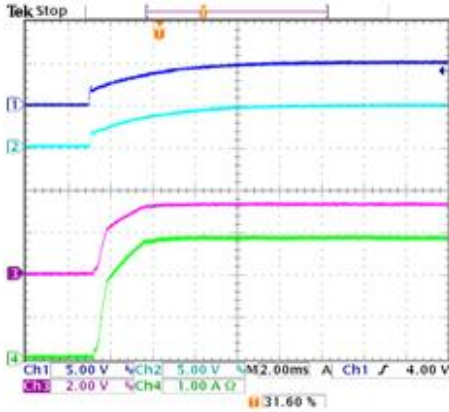

Enable ON

$V_{IN}=5V, V_{OUT}=3.3V, I_{OUT}=2.9A$ ($C_{REF}=10nF$)

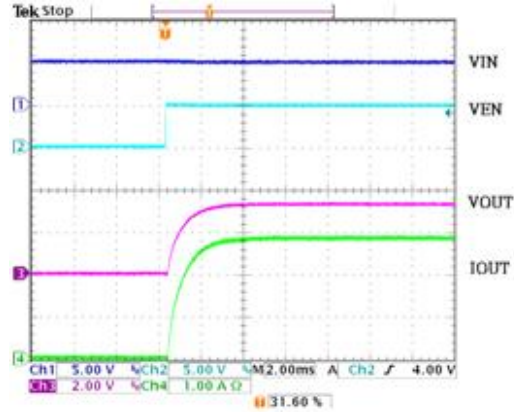

Load transient response

$V_{IN}=5V, V_{OUT}=1.2V, I_{OUT}=0.3A\sim 3.0A$

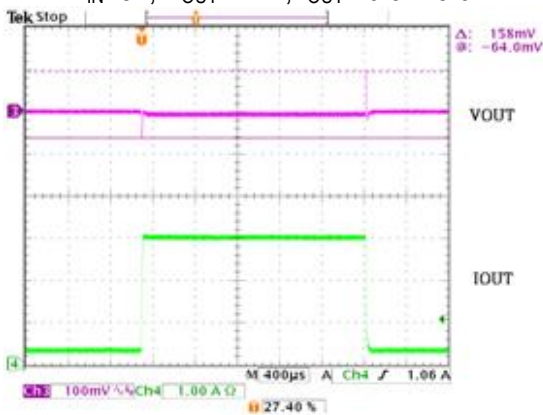

Load transient response

$V_{IN}=5V, V_{OUT}=3.3V, I_{OUT}=0.3A\sim 3.0A$

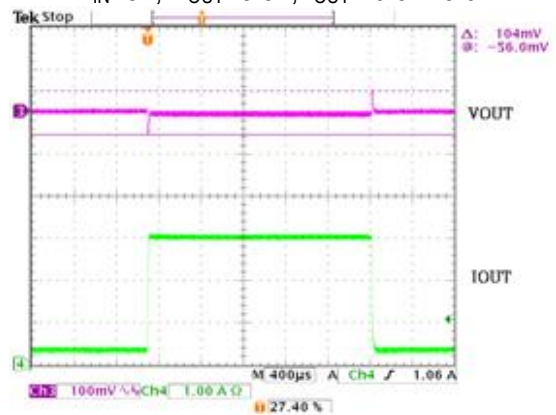

❖ PACKAGE OUTLINES

(1) SOP-8L-EP

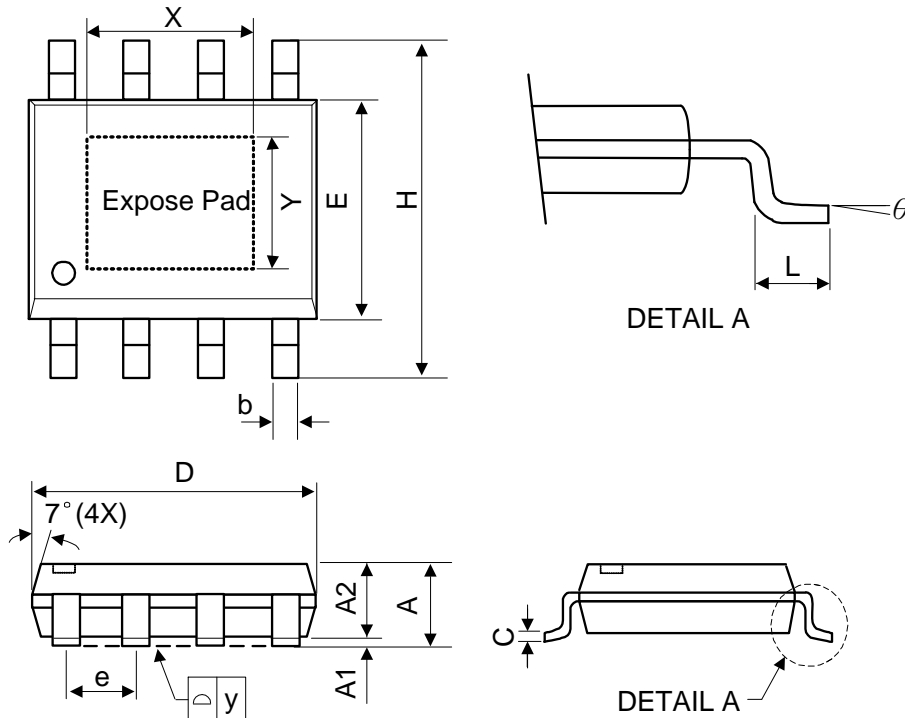

Symbol	Dimensions in Millimeters			Dimensions in Inches		
	Min.	Nom.	Max.	Min.	Nom.	Max.
A	-	-	1.75	-	-	0.069
A1	0	-	0.15	0	-	0.06
A2	1.25	-	-	0.049	-	-
C	0.1	0.2	0.25	0.0075	0.008	0.01
D	4.7	4.9	5.1	0.185	0.193	0.2
E	3.7	3.9	4.1	0.146	0.154	0.161
H	5.8	6	6.2	0.228	0.236	0.244
L	0.4	-	1.27	0.015	-	0.05
b	0.31	0.41	0.51	0.012	0.016	0.02
e	1.27 BSC			0.050 BSC		
y	-	-	0.1	-	-	0.004
X	-	2.34	-	-	0.092	-
Y	-	2.34	-	-	0.092	-
θ	0°	-	8°	0°	-	8°

Mold flash shall not exceed 0.25mm per side
JEDEC outline: MS-012 BA

(2) TDFN-8L (3*3 0.75mm)

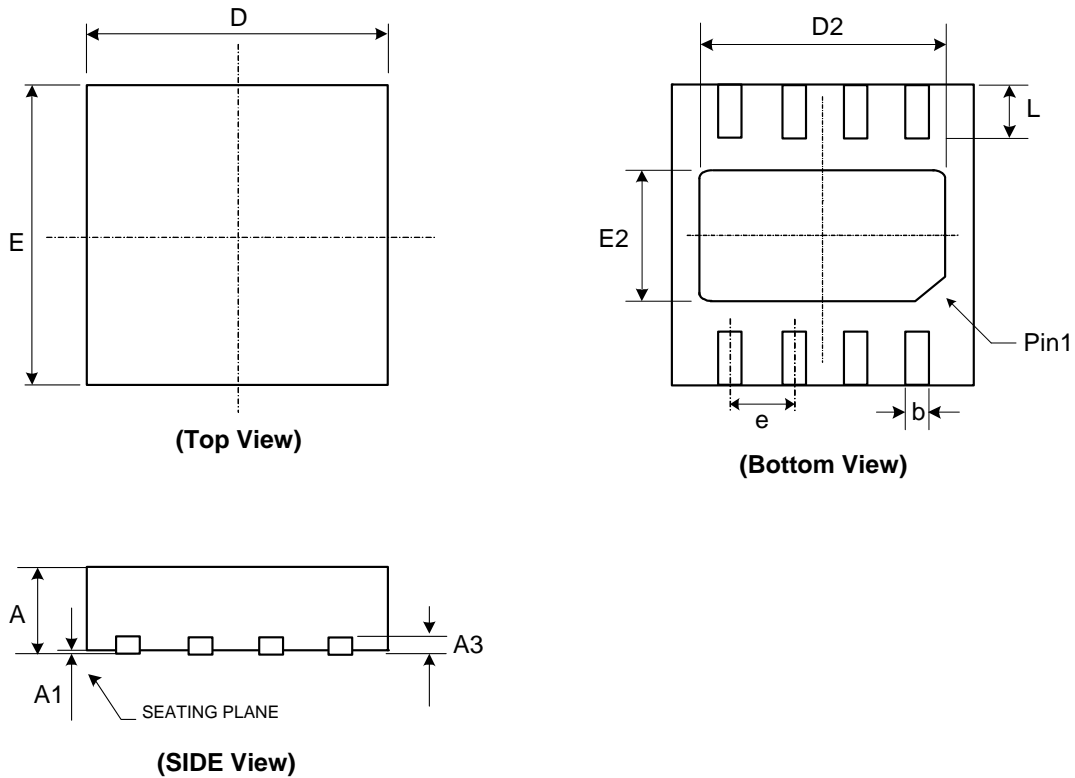

Symbol	Dimensions in Millimeters			Dimensions in Inches		
	Min.	Nom.	Max.	Min.	Nom.	Max.
A	0.70	0.75	0.80	0.028	0.030	0.031
A1	0.00	0.02	0.05	0.000	0.001	0.002
A3	0.203 REF.			0.008 REF.		
b	0.23	0.30	0.35	0.009	0.012	0.014
D	2.90	3.00	3.10	0.114	0.118	0.122
D2	2.30	2.40	2.50	0.091	0.094	0.098
E	2.90	3.00	3.10	0.114	0.118	0.122
E2	1.50	1.60	1.70	0.059	0.063	0.070
e	0.65 BSC.			0.026 BSC.		
L	0.25	0.38	0.50	0.012	0.015	0.020