

85KHz, 2A PWM Buck DC/DC Converter

❖ GENERAL DESCRIPTION

The AX3007A series are monolithic IC designed for a step-down DC/DC converter, and own the ability of driving a 2A load without additional transistor. It saves board space. The external shutdown function can be controlled by logic level and then come into standby mode. The internal compensation makes feedback control having good line and load regulation without external design. Regarding protected function, thermal shutdown is to prevent over temperature operating from damage, and current limit is against over current operating of the output switch. If current limit function occurs and V_{FB} is down below 0.5V, the switching frequency will be reduced.

The AX3007A series operates at a switching frequency of 85KHz thus allow smaller sized filter components than what would be needed with lower frequency switching regulators. The output version included fixed 3.3V, 5V, 12V, and an adjustable type. The chips are available in standard SOP-8L and SOP-8L-EP packages.

❖ FEATURES

- Output voltage: 3.3V, 5V, 12V and adjustable output version.
- Adjustable version output voltage range, 1.23V to 38.5V.
- 85KHz fixed switching frequency.
- Voltage mode non-synchronous PWM control.
- Thermal-shutdown and current-limit protection.
- ON/OFF shutdown control input.
- Short Circuit Protect (SCP).
- Operating voltage can be up to 40V.
- Output load current: 2A.
- SOP-8L and SOP-8L with Exposed Pad Pb-Free packages.
- Low power standby mode.
- Built-in switching transistor on chip.
- RoHS and Halogen free compliance.

❖ BLOCK DIAGRAM

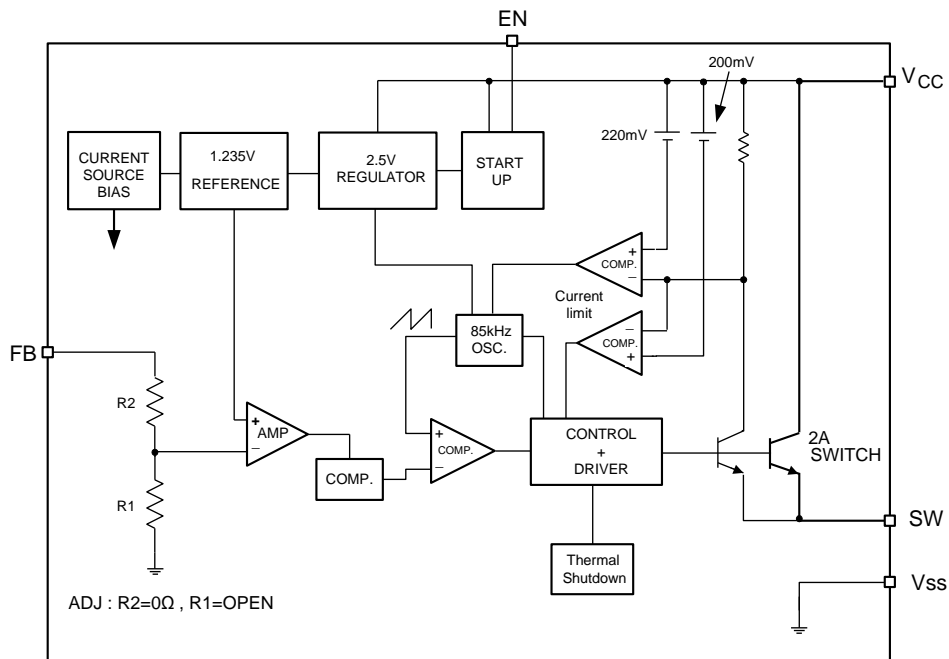

❖ PIN ASSIGNMENT

The packages of AX3007A are SOP-8L and SOP-8L-EP.

The pin assignment is given by:

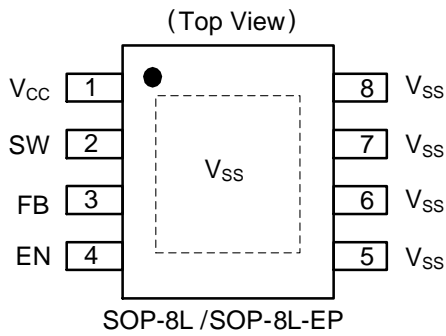

Name	Description
V _{CC}	Operating voltage input
SW	Switching output
FB	Output voltage feedback control
EN	ON/OFF Shutdown
V _{SS}	GND pin
V _{CC}	Operating voltage input

❖ **ORDER INFORMATION**

Order Information	
AX3007A-XX XX X Output Voltage Package Type Packing 33: 3.3V S: SOP-8L Blank : Tube 50: 5.0V ES: SOP-8L-EP A : Taping 12: 12V Blank:ADJ	
Top Marking (SOP-8L/SOP-8L-EP)	
ADJ 	FIX

❖ **ABSOLUTE MAXIMUM RATINGS**

Characteristics	Symbol	Rating	Unit
Maximum Supply Voltage	V_{CC}	+45	V
ON/OFF Pin Input Voltage	V_{EN}	-0.3 to 40	V
Feedback Pin Voltage	V_{FB}	-0.3 to 20	V
Output Voltage to Ground	V_{OUT}	-0.8	V
Power Dissipation Internally limited	PD	$(T_J - T_A) / \theta_{JA}$	W
Storage Temperature Range	T_{ST}	-65 to +150	°C
Operating Junction Temperature Range	T_J	-40 to +125	°C
Operating Supply Voltage	V_{OP}	+4.5 to +40	V
Thermal Resistance from Junction to case	SOP-8L	20	°C/W
	SOP-8L-EP	15	
Thermal Resistance from Junction to ambient	SOP-8L	60	°C/W
	SOP-8L-EP	50	

Note: θ_{JA} is measured with the PCB copper area (need connect to V_{SS} pins) of approximately 1.5 in² (Multi-layer).

❖ ELECTRICAL CHARACTERISTICS

(Unless otherwise specified, $T_A=25^{\circ}\text{C}$, $V_{CC}=12\text{V}$ for 3.3V, 5V, adjustable version and $V_{CC}=18\text{V}$ for the 12V version. $I_{LOAD} = 0.2\text{A}$)

Characteristics	Symbol	Conditions	Min	Typ	Max	Units
Quiescent Current	I_Q	$V_{FB}=1.5\text{V}$ for Adjustable version force driver off	-	4	8	mA
Feedback bias current	I_{FB}	$V_{FB}=1.3\text{V}$ (Adjustable version only)	-	-10	-500	nA
Shutdown supply Current	I_{SD}	EN pin=5V $V_{CC}=40\text{V}$	-	100	200	μA
Oscillator frequency	F_{OSC}		70	85	100	KHz
Oscillator frequency of short circuit protect	F_{SCP}	(Adjustable) When $V_{FB}<0.5\text{V}$	-	25	-	KHz
		(Fixed)When $< V_{OUT}^*40\%$	-	25	-	KHz
Max. Duty Cycle (ON)	DC	$V_{FB}=0\text{V}$ force driver on	-	100	-	%
Min. Duty Cycle (OFF)		$V_{FB}=1.5\text{V}$ for Adjustable version force driver off	-	0	-	
Current limit	I_{CL}	Pear current, No outside circuit $V_{FB}=0\text{V}$ force driver on	2.2	-	-	A
Load Regulation($\Delta V_{OUT}/V_{OUT}$)	ΔV_{OUT}	$I_{OUT} = 0.2$ to 2A	-	0.6	1.2	%
Saturation voltage	V_{SAT}	$I_{OUT}=2\text{A}$, No outside circuit $V_{FB}=0\text{V}$ force driver on	-	1.2	1.4	V
SW pin leakage current	I_{SWL}	No outside circuit $V_{FB}=1.5\text{V}$ for Adjustable version force driver off	-	-	-200	μA
		$V_{CC}=40\text{V}$ force driver off	-	-5	-	mA
EN pin logic input threshold voltage	V_{IL}	Low (regulator ON)	-	1.3	0.6	V
	V_{IH}	High (regulator OFF)	2.0		-	
EN pin logic input current	I_H	$V_{EN}=2.5\text{V}$ (OFF)	-	-0.1	-10	μA
EN pin input current	I_L	$V_{EN}=0.5\text{V}$ (ON)	-	-0.01	-1.5	
Thermal shutdown Temp	T_{SD}		-	150	-	$^{\circ}\text{C}$

❖ ELECTRICAL CHARACTERISTICS (CONTINUED)

Version	Characteristics	Symbol	Conditions	Min	Typ	Max	Units
AX3007A-ADJ	Output Feedback voltage	V_{FB}	$I_{LOAD} = 0.2A$ V_{OUT} programmed for 3.3V	1.193	1.23	1.267	V
	Efficiency	η	$V_{CC}=12V, I_{LOAD}=2A$	-	78	-	%
AX3007A-3.3V	Output voltage	V_{OUT}	$I_{LOAD} = 0.2A$	3.20	3.30	3.40	V
	Efficiency	η	$V_{CC}=12V, I_{LOAD}=2A$	-	78	-	%
AX3007A-5.0V	Output voltage	V_{OUT}	$I_{LOAD} = 0.2A$	4.85	5.00	5.15	V
	Efficiency	η	$V_{CC}=12V, I_{LOAD}=2A$	-	82	-	%
AX3007A-12V	Output voltage	V_{OUT}	$I_{LOAD} = 0.2A$	11.64	12.0	12.36	V
	Efficiency	η	$V_{CC}=15V, I_{LOAD}=2A$	-	90	-	%

❖ APPLICATION CIRCUIT

(1) Adjustable Output Voltage Version

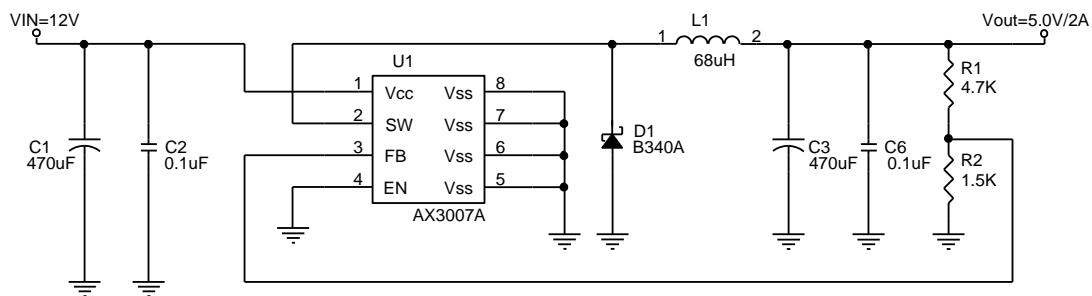

(2) Adjustable Output Voltage Version with Delayed Startup

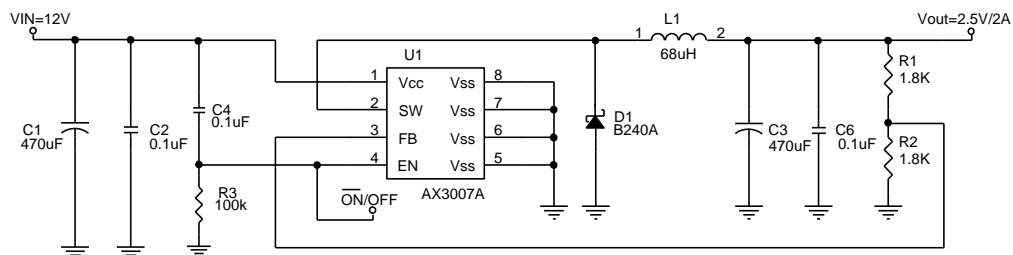

$$V_{OUT} = V_{FB} \times \left(1 + \frac{R1}{R2}\right), V_{FB} = 1.23V, R2 = 0.47K \sim 3K$$

Table 1 Resistor select for output voltage setting

V _{OUT}	R2	R1
5V	1.5K	4.7K
	1.8K	5.6K
3.3V	1.5K	2.5K
	1.8K	3.0K
2.5V	1.8K	1.8K
1.8V	1.8K	0.82K

L1 recommend value (I _{OUT} =2A,)				
V _{OUT}	2.5V	3.3V	5V	12V
V _{IN} =12V	68uH	68uH	68uH	NA
V _{IN} =24V	68uH	68uH	68uH	100uH

(3) Fixed Output Voltage Version

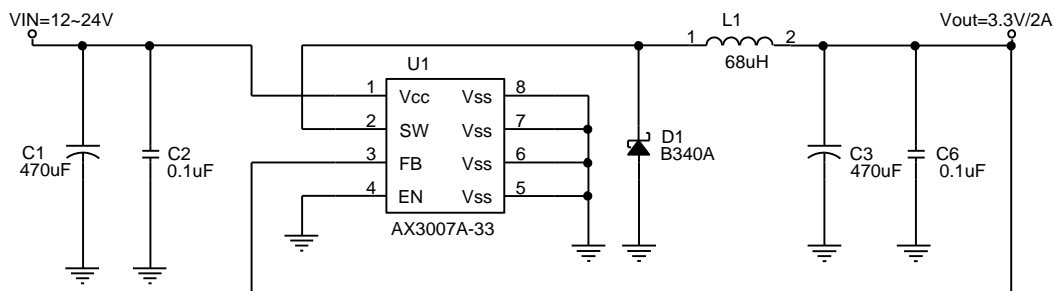

❖ FUNCTION DESCRIPTION

Pin Functions

V_{CC}

This is the positive input supply for the IC switching regulator. A suitable input bypass capacitor must be presented at this pin to minimize voltage transients and to supply the switching currents needed by the regulator.

V_{SS}

Circuit ground.

SW

Internal switch. The voltage at this pin switches between $(+V_{CC} - V_{SAT})$ and approximately $-0.5V$, with a duty cycle of approximately V_{OUT} / V_{CC} . To minimize coupling to sensitive circuitry, the PC board copper area connected to this pin should be minimized.

Feedback

Senses the regulated output voltage to complete the feedback loop.

EN

Allows the switching regulator circuit to be shutdown using logic level signals thus dropping the total input supply current to approximately $100\mu A$. Pulling this pin below a threshold voltage of approximately $1.3V$ turns the regulator on, and pulling this pin above $1.3V$ (up to a maximum of V_{CC}) shuts the regulator down. If this shutdown feature is not needed, the EN pin can be wired to the ground pin.

Thermal Considerations

The SOP-8L package needs a heat sink under most conditions. The size of the heat sink depends on the input voltage, the output voltage, the load current and the ambient temperature. The AX3007A junction temperature rises above ambient temperature for a 2A load and different input and output voltages.

The data for these curves was taken with the AX3007A (SOP-8L package) operating as a buck-switching regulator in an ambient temperature of $25^{\circ}C$ (still air). These temperature increments are all approximate and are affected by many factors. Higher ambient temperatures require more heat sinker.

For the best thermal performance, wide copper traces and generous amounts of printed circuit board copper (need connect to the V_{SS} pins) should be used in the board layout, (One exception is the SW(switch) pin, which should not have large areas of copper.) Large areas of copper provide the best transfer of heat (lower thermal resistance) to the surrounding air, and moving air lowers the thermal resistance even further.

Package thermal resistance and junction temperature increments are all approximate. The increments are affected by a lot of factors. Some of these factors include board size, shape, thickness, position, location, and even board temperature. Other factors are, trace width, total printed circuit copper area, copper thickness, single or double-sided, multi-layer board and the amount of solder on the board.

The effectiveness of the PC board to dissipate heat also depends on the size, quantity and spacing of other components on the board, as well as whether the surrounding air is still or moving. Furthermore, some of these components such as the catch diode will add heat to the PC board and the heat can vary as the input voltage changes. For the inductor, depending on the physical size, type of core material and the DC resistance, it could either act as a heat sink taking heat away from the board, or it could add heat to the board.

❖ TYPICAL CHARACTERISTICS

Output Ripple

($V_{IN}=12V, V_{OUT}=3.3V, I_{OUT}=2A$)

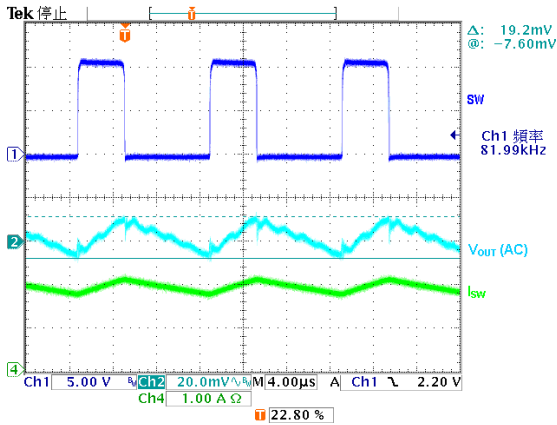

Power on test wave

($V_{IN}=12V, V_{OUT}=5V, I_{OUT}=2A$)

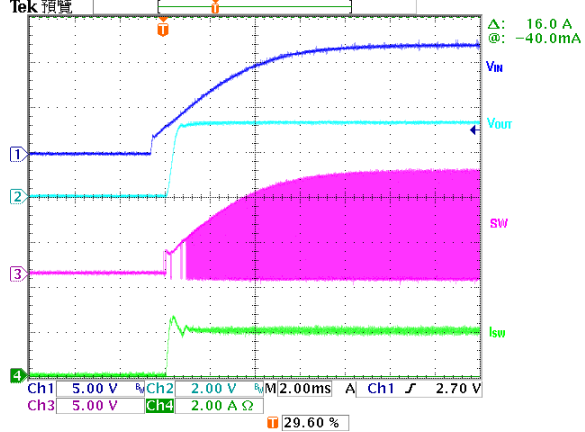

Load Transient Response

($V_{IN}=12V, V_{OUT}=3.3V, I_{OUT}=0.2\sim 2A$)

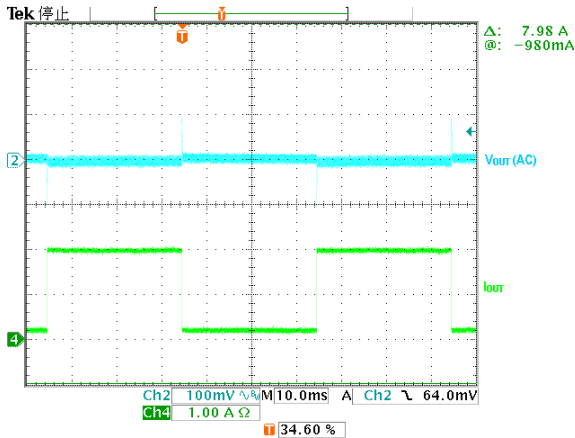

EN on test wave

($V_{IN}=12V, V_{OUT}=5V, I_{OUT}=2A$)

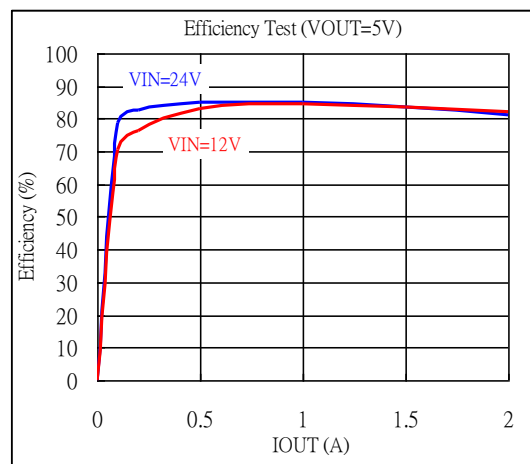
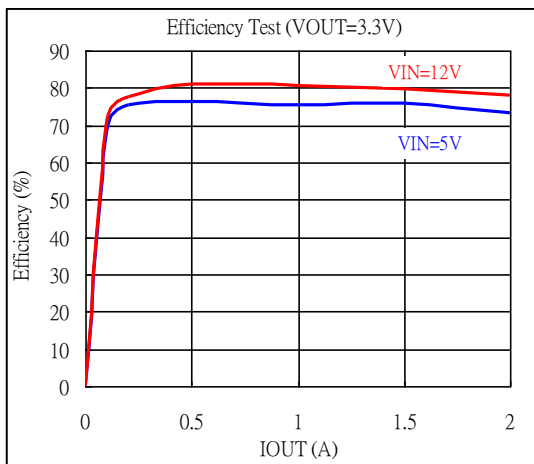
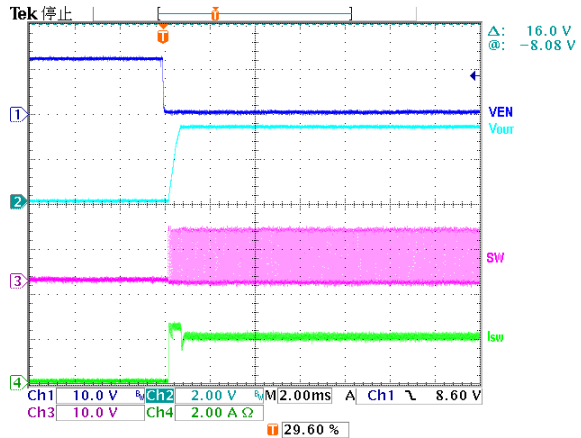

❖ PACKAGE OUTLINES

(1) SOP-8L

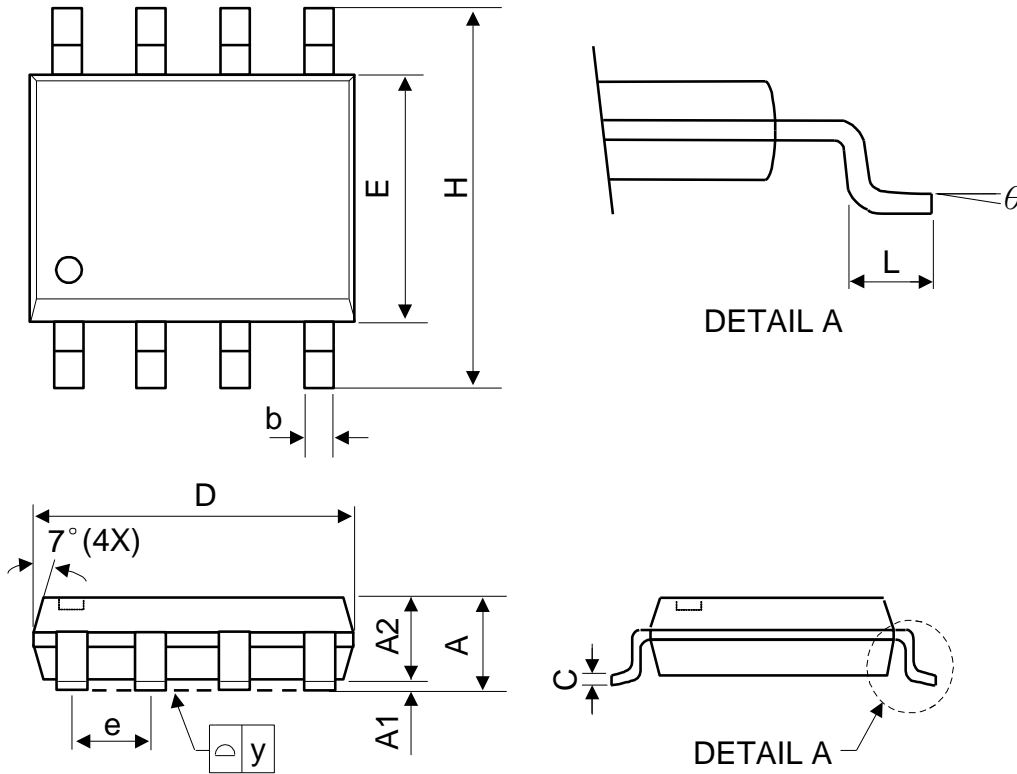

Symbol	Dimensions in Millimeters			Dimensions in Inches		
	Min.	Nom.	Max.	Min.	Nom.	Max.
A	-	-	1.75	-	-	0.069
A1	0.1	-	0.25	0.04	-	0.1
A2	1.25	-	-	0.049	-	-
C	0.1	0.2	0.25	0.0075	0.008	0.01
D	4.7	4.9	5.1	0.185	0.193	0.2
E	3.7	3.9	4.1	0.146	0.154	0.161
H	5.8	6	6.2	0.228	0.236	0.244
L	0.4	-	1.27	0.015	-	0.05
b	0.31	0.41	0.51	0.012	0.016	0.02
e	1.27 BSC			0.050 BSC		
y	-	-	0.1	-	-	0.004
θ	0°	-	8°	0°	-	8°

Mold flash shall not exceed 0.25mm per side

JEDEC outline: MS-012 AA

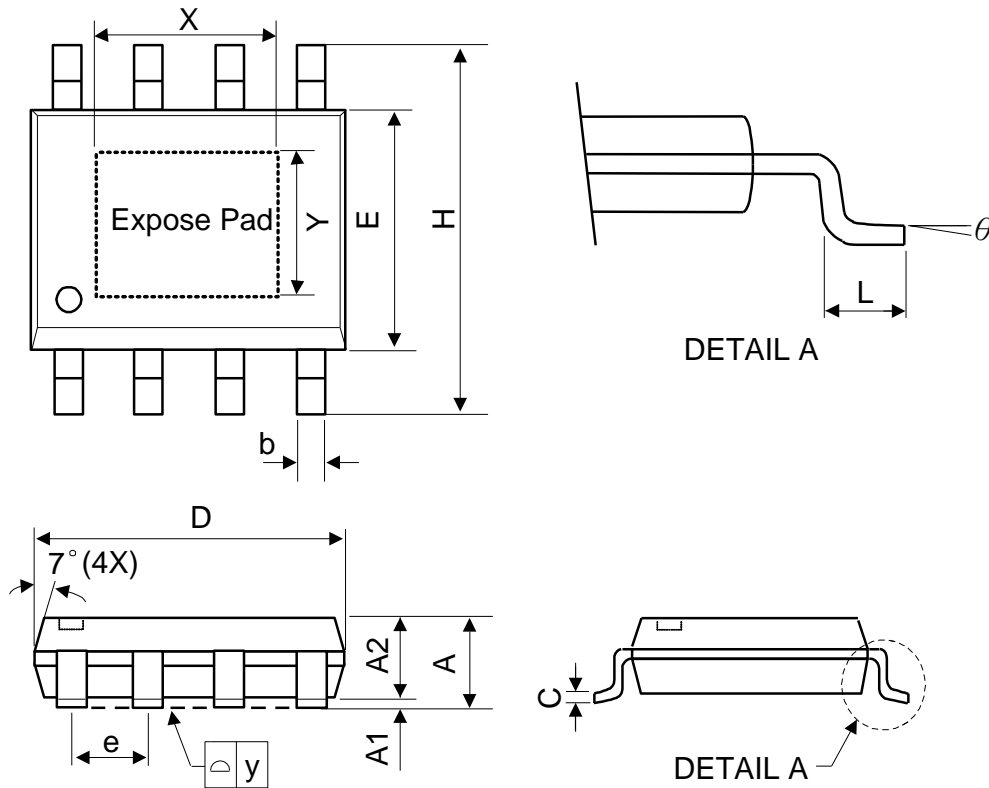
(2) SOP-8L-EP

Symbol	Dimensions in Millimeters			Dimensions in Inches		
	Min.	Nom.	Max.	Min.	Nom.	Max.
A	-	-	1.75	-	-	0.069
A1	0	-	0.15	0	-	0.06
A2	1.25	-	-	0.049	-	-
C	0.1	0.2	0.25	0.0075	0.008	0.01
D	4.7	4.9	5.1	0.185	0.193	0.2
E	3.7	3.9	4.1	0.146	0.154	0.161
H	5.8	6	6.2	0.228	0.236	0.244
L	0.4	-	1.27	0.015	-	0.05
b	0.31	0.41	0.51	0.012	0.016	0.02
e	1.27 BSC			0.050 BSC		
y	-	-	0.1	-	-	0.004
X	-	2.34	-	-	0.092	-
Y	-	2.34	-	-	0.092	-
θ	0°	-	8°	0°	-	8°

Mold flash shall not exceed 0.25mm per side
JEDEC outline: MS-012 BA

❖ CARRIER TAPE DIMENSION

(1) SOP-8L

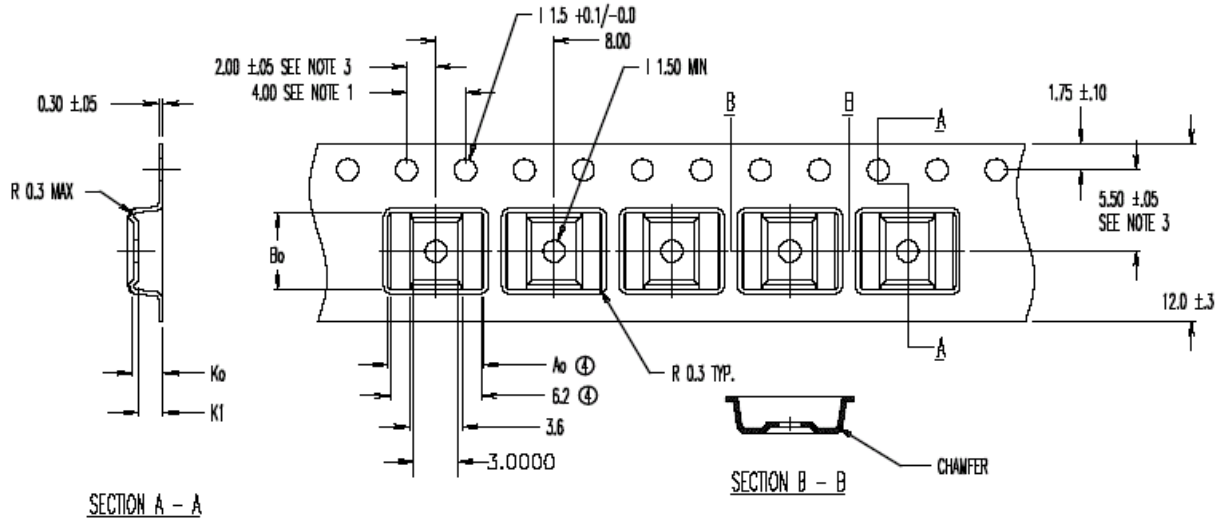

- ⓐ ⊕ A₀ = 6.50
- ⓐ ⊕ B₀ = 5.20
- ⓐ ⊕ K₀ = 2.10
- ⓐ ⊕ K₁ = 1.70

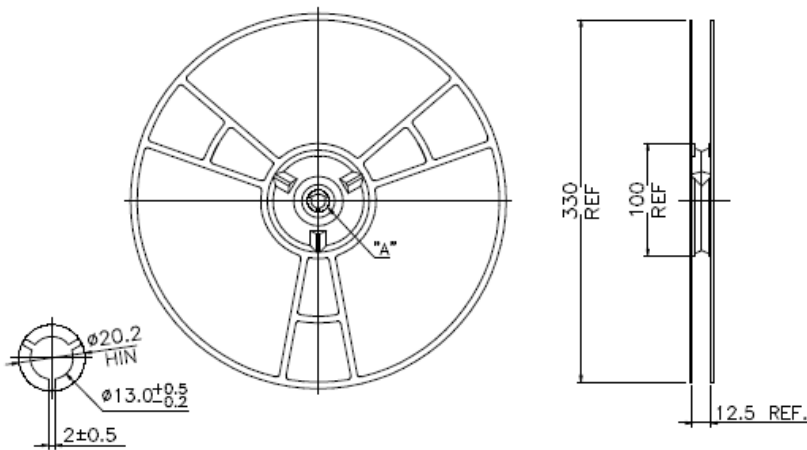

(2) SOP-8L-EP

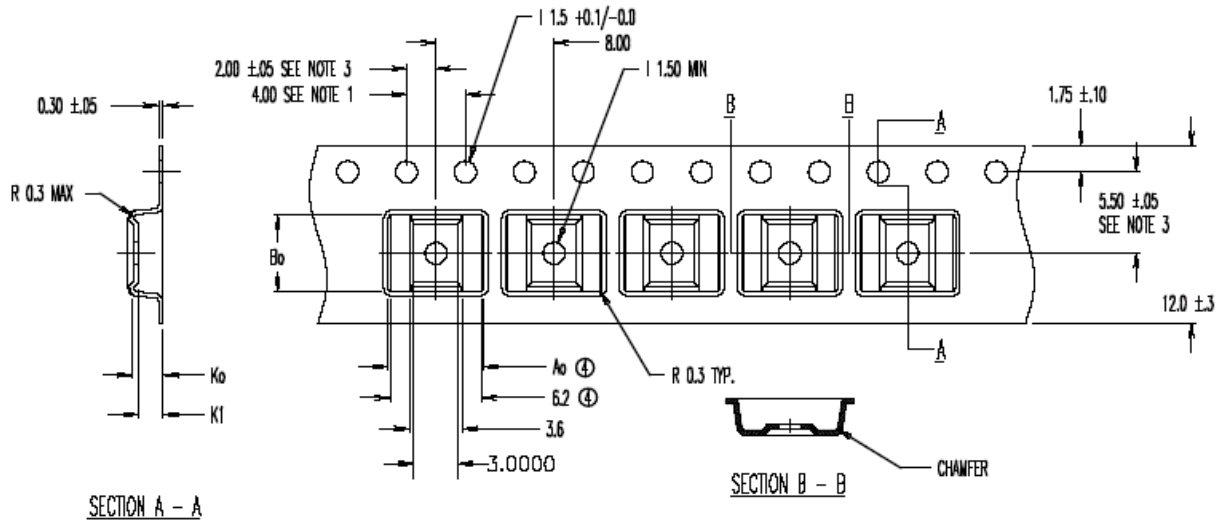

- Ⓢ $A_0 = 6.50$
- $B_0 = 5.20$
- $K_0 = 2.10$
- $K_1 = 1.70$

